

# INSTRUCTION MANUAL FOR CONTROL SYSTEM OF INJECTION MOLDING MACHINE

FIRMWARE VERSION 3.0

VIBRANT

STREAMLINE



Streamline Controls Pvt. Ltd. (SCPL) is in the business of providing electronic & computerized Automation solution for different industries so as to enhance the quality and productivity. Our motto is to provide indigenous, reliable and proven products & hence to ensure consistent Performance. Our concept of value to the customers is to supply indigenous control systems Designed with latest technology, developed through extensive R & D, incorporating state of Art technology (world technology trend), manufactured under strictest quality control system And duly tested, at competitive prices, delivered in time and supported by service teams.

We feel it to be our responsibility to ensure that our business operates at a reasonable profit, as profit provides opportunity for R&D, growth and job security. Therefore we are dedicated to profitable growth - growth as a company and growth as an individual.

For detailed inquiry and troubleshooting contact:

STREAMLINE CONTROLS PVT.LTD.

401/402,"meghansh"complex, opp. Oxford tower,

Gurukul road, Memnagar, Ahmedabad-380 052.

Gujarat, India.

Phone. – 919328808665/9328808669 (Customer Care)

E-mail – [customercare@Streamlinecontrols.com](mailto:customercare@Streamlinecontrols.com)

Website: [www.streamlinecontrols.com](http://www.streamlinecontrols.com)

## PREFACE

INJkon is multi functional controller incorporating micro controller, making it most versatile and cost effective solution optimally designed to best suit the automation needs of injection molding machines.

For letter usage and maintenance of control system, detail study of this operating manual will be helpful. We would be glad to assist your quarries.



STREAMLINE

**CONTENTS**

- (A) SYSTEM SPECIFICATIONS
- (B) INTRODUCTION
- (C) FEATURES
- (D) SCOPE OF SUPPLY
- (E) PROGRAMMING OF THE SYSTEM
- (F) OPERATING PANEL DESCRIPTION
- (G) MANUAL MODE OF OPERATION
- (H) PRECAUTIONS
- (I) SETTING PROCEDURES FOR:
  - (1) TEMPERATURE CONTROLLER
  - (2) TIMERS
  - (3) MISC.FUNCTIONS
  - (4) Pressure
- (J) WIRING DIAGAM
- (J) Home, About us, Password Function Page:
- (K) DESCRIPTION OF TEST MODES:
  - (1) OUTPUT
  - (2) TEMPERATURE
- (L) FUNCTIONAL DESCRIPTION OF:
  - (1) HEAT OFF FUNCTION
  - (2) HAND
  - (3) SEMI AUTO
  - (4) FULLY AUTO
- (M) INTERLOCKS
- (N) LIST OF I/P AND O/P



**(A) SPECIFICATIONS:**

**Input**

**Power:**  
Voltage -- 24VDC  $\pm$  1%VDC

**Control:**  
Thermocouple -- J / K type - Isolated  
Proximity/ -- NPN (NO type)  
Limit switches 10-30 Vdc - 50 mA Max.

**Output**

For Solenoids -- For 24VDC - 2 Amp. Max. – MOSFET Driver Output

**Environment**

Temperature -- 0°C to 55°C  
Humidity -- 5 to 95% RH non-condensing

STREAMLINE CONTROLS



## (B) INTRODUCTION

INJkon is a complete proven & reliable control system for Injection Molding Machine. System consists of two units.

- (1) MMI unit
- (2) SMPS

### (1) Operating Panel:

This is small lightweight Display unit with soft touch keypad & LCD display, digital input, digital output and temperature section.

This package has some obvious advantages over existing conventional Electrical Systems. This occupies lesser space than conventional system. The simplicity of wiring from solenoids to systems or limit switches to system and from Thermocouples to system makes it easier and less time consuming for commissioning. This system has no moving parts, so periodical maintenance is drastically reduced and there for reliability is definitely improved. Function like suck back ON-OFF, Heating ON-OFF and Cycle Time Interlock makes this system much more superior then the conventional system.

## (C) FEATURES

- Inherently reliable high speed Micro controller based technology C8051F120 CPU.
- Offers 12 digital inputs, 20 digital outputs, 8-zone time Proportional controlled Temperature Controllers, 1 pressure output , timers, Extensive feather touch membrane keypad for user interface for manual/Semi auto/fully auto functions of the machine.
- Latest E2PROM Technology ensures security of programmed parameters.
- User friendly programming through an extensive membrane keypad for easy operator interface (Details of manual mode operations available is appended on separate sheet)
- Six digit shot counter to count Number of Pieces.
- Facility for counting cycle time helpful in production analysis.
- Three different programs for Ejector operations provide to suit the operational needs with various molds.
- Thermocouple "Open" & "Reverse" conditions are self-detected and are displayed as "Opn" and "rev" respectively.
- Programmable High & Low limits for all temperature zones.
- Automatic cold junction compensation for Thermocouple inputs.
- Mold Safety interlock provided in case of abnormal pressure rise while the mold is getting closed (For that pressure switch input has to be provided.)
- Inbuilt interlocks for Low & High temperature, Front and/or Back guards, Maximum Cycle Time, Emergency stop etc.
- Operating Input/output diagnosis.



**(D) SCOPE OF SUPPLY**

Streamline Controls to provide:

1. Hand Panel.
2. Operating Manual.

**(E) PROGRAMMING OF THE SYSTEM**

The system will be programmed to suit your application by us.

STREAMLINE CONTROLS

**(F) OPERATING PANEL DESCRIPTION**

**Key's Description**

**1. Cursor K**

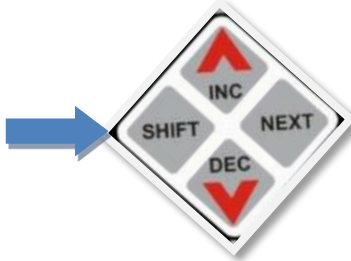

Shift Key - Press this key to move cursor from left to right direction for parameter setting in Any menu. Show Main Screen Press Shift Key to Show Set Temperature.

INC Key - To increase parameter value in any menu Also use for function on/Off. Temperature Calibration Mode: To increase Temperature value

DEC Key - To decrease parameter value in any menu. Also use for function on/Off. Show Main Screen Press Decrease Key to Show % Output. Temperature Calibration Mode: TO Decrease Temperature Value

NEXT Key- Press this key to Save Parameter in any Manu.



Scroll - To move Cursor in UP & DOWN side Of parameter.

Page - To select Page UP & DOWN in any open program page.

**2. Menu Selector**



Set temperature key for set all zones set point.



Set timer key for set all function's timer.



Set misc key to do set On/ Off for selectable function.



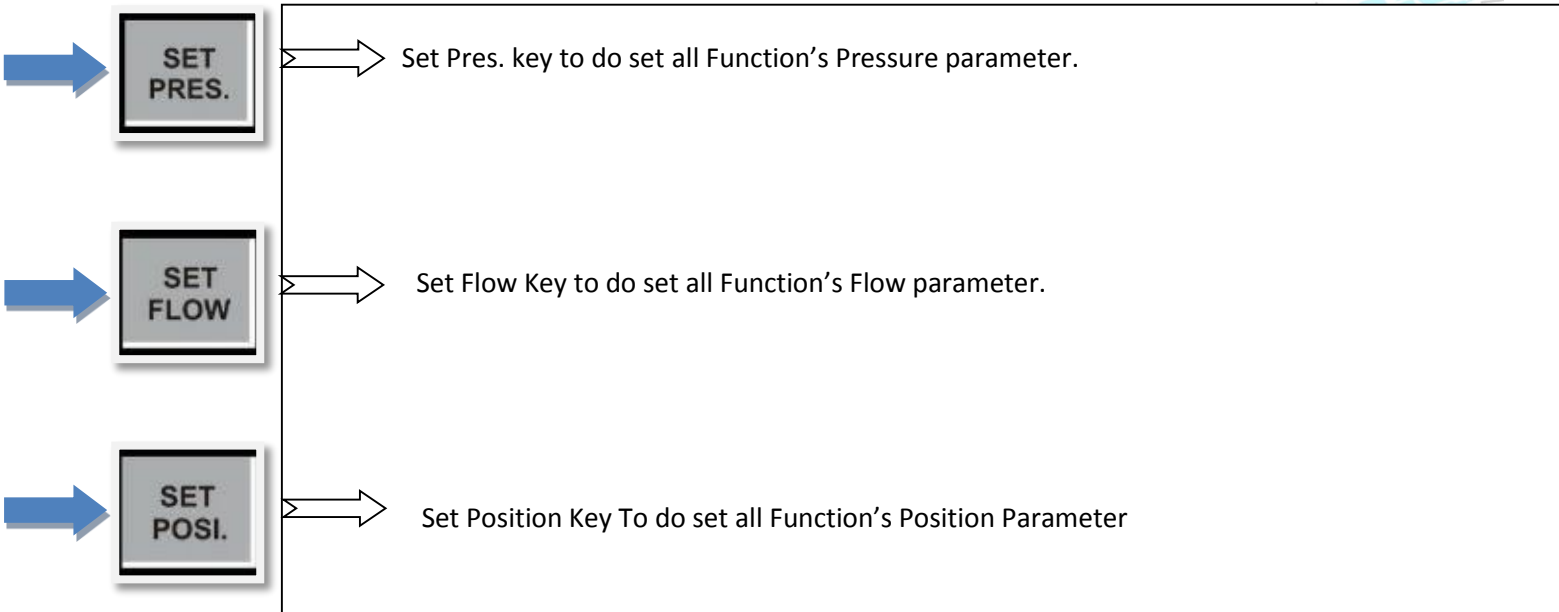

**3. Operating Mode Selector**

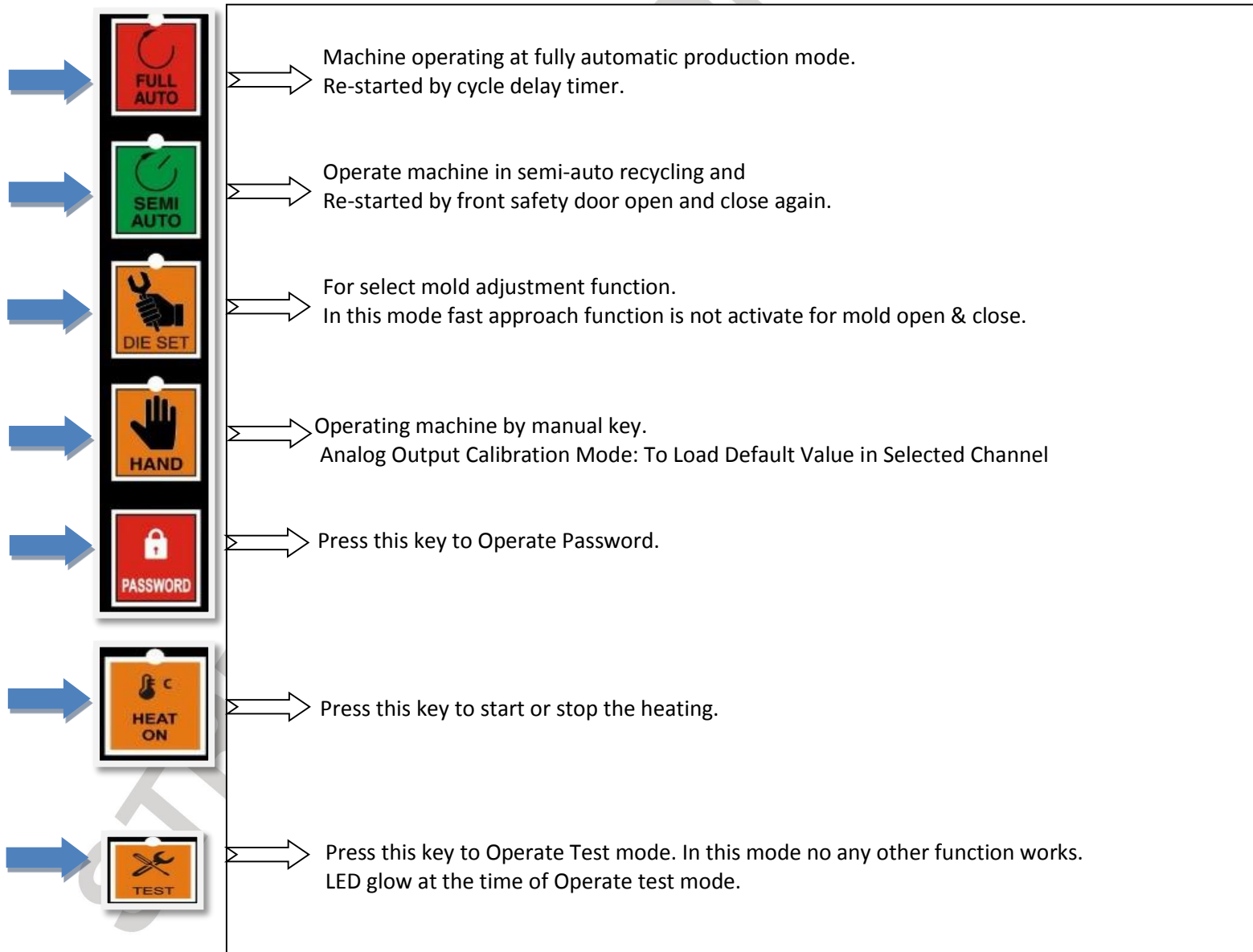

4. Manual Operation Key

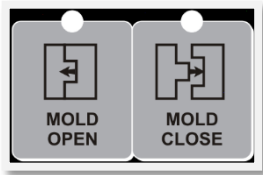

Mold Open Key  
Press for activate of mold opening action manually.  
Mold Close Key  
Press for activate of mold clamping action manually.

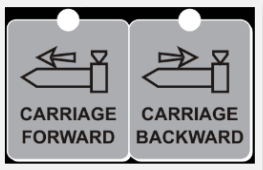

Carriage Forward Key  
Press for activate of Carriage Forward action manually.  
Carriage Backward Key  
Press for activate of Carriage Backward action manually.

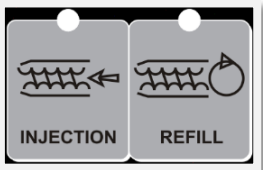

Injection Key  
Press for activate of Injection action manually.  
(Disable by any zone of barrel temperature is lower than alarm low setting).  
Refill Key  
Press for activate of Refill action manually.  
(Disable by any zone of barrel temperature is lower than alarm low setting).

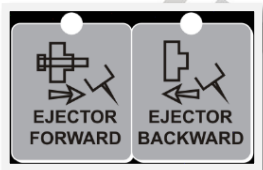

Ejector Forward Key  
Press for activate of Ejector Forward action manually.  
Ejector Backward Key  
Press for activate of Ejector Backward action manually.

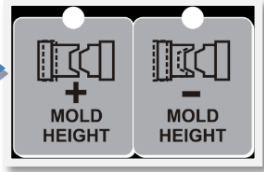

Mold Height + Key  
 Press for activate of Mold Height + action manually.  
 (Work only in Die set mode)  
 Mold Height - Key  
 press for activate of Mold Height - action manually.  
 (Work only in Die set mode)

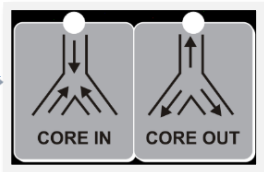

Core In Key  
 Press for activate of Core In action manually.  
 Core Out Key  
 Press for activate of Core Out action manually.

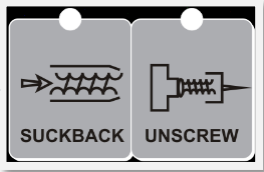

Suck Back Key  
 Press for activate of Suck Back action manually.  
 (Disable by any zone of barrel temperature is lower than alarm low setting)  
 UNSCREW Key  
 Press for activate of unscREW action manually.

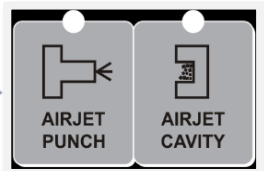

Air Jet Punch Key  
 Press for activate of Air Jet Punch action manually.(For moveable platen)  
 Air Jet Cavity Key  
 Press for activate of Air Jet Cavity action manually.(For fix platen).

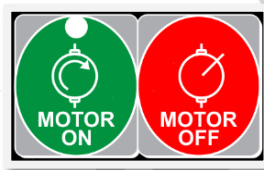

Motor ON Key  
 Press for activate of motor on action manually.  
 Motor off Key  
 Press for activate Motor off action manually.

STREAMLINE



## (G) MANUAL MODE OF OPERATIONS

- |                     |                       |
|---------------------|-----------------------|
| 1. Mold Open        | 11. Mold Close        |
| 2. Carriage Forward | 12. Carriage backward |
| 3. Ejector Forward  | 13. Ejector Backward  |
| 4. Injection        | 14. Refill            |
| 5. Core in (I)      | 15. Core Out (I)      |
| 6. Suck Back        | 16. Spare key         |
| 7. Core in (II)     | 17. Core Out (II)     |
| 8. Air jet Punch    | 18. Airjet cavity     |
| 9. Mold Height (+)  | 19. Mold Height (-)   |
| 10. Motor on        | 20. Motor Off         |

## (H) PRECAUTIONS to prevent damage from human and machine, please obey the following safety caution.

- Equipment must be operating under correct power. (Install a voltage stabilizer while need)
- Earth terminal must be connected to qualified terminal.
- All electrical elements with EARTH terminal, it is necessary for users to connect with the EARTH terminal.
- The high power cables should be separated from the low power cables to avoid interferes.
- TO prevent fire or hazard shock, do not expose the unit to rain or moistly place.
- Please understand the operating process before use.
- When system shut down, wait 10 seconds for re-start.
- Thermocouples used for this system must be isolated (ungrounded) Fe/k ,J type.
- The wiring of each zone starting from thermocouple of heater must be verified.  
For ex: first zone thermocouple must be connected to first channel of the system and heater of first zone must be connected to heater 1 of the system.
- The limit switch and solenoids wiring must be done as per given wiring diagram.
- If the proximity switches are used then use only NPN-NO type proximity switches.



**(I) SETTING PROCEDURES**

**(1) TEMPERATURE CONTROLLERS:**

Here two different levels of programming is provided

- 1. Operator Level.
- 2. Engineers Level.

In case of operator level only set value of temperature can be changed where as in case of other level all other parameters can be changed.

**1. Operator Level.**

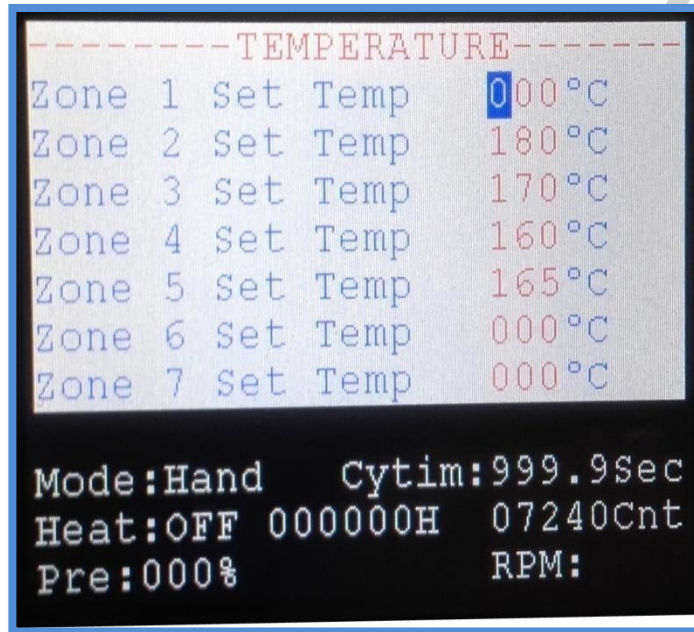

**Set Temperature**

**In case of operator level**

Press **SET TEMP.** key.

First line of LCD shows TEMPERATURE C.

Second line of LCD shows zone number & set temperature.

Select require zone using **Scroll UP/DOWN** key.

Select Down/UP side parameter Using **Page UP/DOWN** key.

Set require temperature using **INC, DEC** and **SHIFT** key.

On pressing **NEXT** key the set value will be saved and display will show the function.

List of temperature parameters are given below.

Zone No.	Message In First Line	Message In Second Line	Description	Range	Default Value	Level
1	Temperature C	Zone 1	Zone 1 set temperature	0-500 C	200 C	User
2	Temperature C	Zone 2	Zone 2 set temperature	0-500 C	200 C	User
3	Temperature C	Zone 3	Zone 3 set temperature	0-500 C	200 C	User
4	Temperature C	Zone 4	Zone 4 set temperature	0-500 C	200 C	User
5	Temperature C	Zone 5	Zone 5 set temperature	0-500 C	200 C	User
6	Temperature C	Zone 6	Zone 6 set temperature	0-500 C	200 C	User
7	Temperature C	Zone 7	Zone 7 set temperature	0-500 C	200 C	User
8	Temperature C	Zone 8	Zone 8 set temperature	0-500 C	200 C	User



2. Engineers Level.

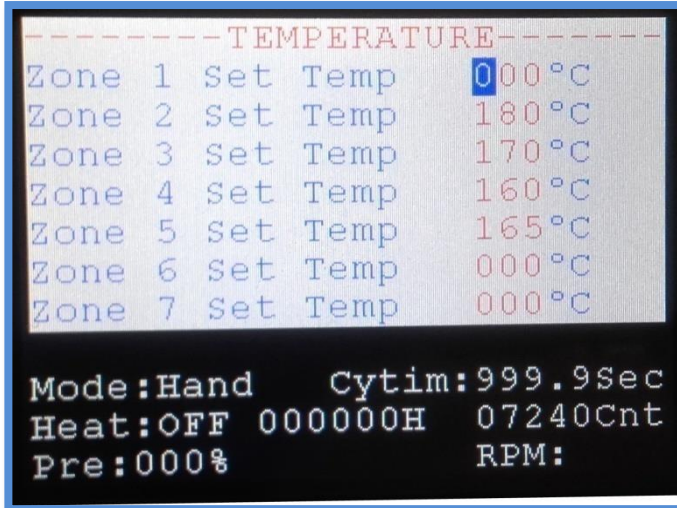

Set Temperature

In case of Engineer level

Press **SET TEMP** key and keep it pressed for at least ten seconds.

First line of LCD shows parameter name.

Second line of LCD shows zone number & parameter value.

Select require parameter using **Scroll UP/DOWN** key.

Select Down/UP side parameter Using **Page UP/DOWN** key.

Set require value using **INC, DEC** and **SHIFT** key.

On pressing **NEXT** key the set value will be saved and display will show the function.

On pressing set temp key the zone number can be changed. Again pressing the Scroll Down key the different parameter of the same zone can be checked.

List of temperature parameters are given below.

ZoneNo.	Message In First Line	Message In Second Line	Description	Range	Default Value	Level
1	Temperature C	Zone 1	Set temperature	0-500 C	200 C	Engineer
	Prop. Band C	Zone 1	Proportional band	0-100 C	030 C	Engineer
	Integr. Time Sec	Zone 1	Integral time	0-999 Sec	900 Sec	Engineer
	Derivt. Time Sec	Zone 1	Derivative time	0-999 Sec	000 Sec	Engineer
	Cycle Time Sec	Zone 1	Cycle time	0-200 Sec	15 Sec	Engineer
	Alarm Low C	Zone 1	Alarm low	0-200 C	025 C	Engineer
	Alarm High C	Zone 1	Alarm High	0-999 C	025 C	Engineer
	Blower Point C	Zone 1	Blower Operating Point	0-999C	005 C	Engineer

2	Temperature C	Zone 2	Set temperature	0-500 C	200 C	Engineer
	Prop. Band C	Zone 2	Proportional band	0-100 C	030 C	Engineer
	Integr. Time Sec	Zone 2	Integral time	0-999 Sec	900 Sec	Engineer
	Derivt. Time Sec	Zone 2	Derivative time	0-999 Sec	000 Sec	Engineer
	Cycle Time Sec	Zone 2	Cycle time	0-200 Sec	15 Sec	Engineer
	Alarm Low C	Zone 2	Alarm low	0-200 C	025 C	Engineer
	Alarm High C	Zone 2	Alarm High	0-999 C	025 C	Engineer
	Blower Point C	Zone 2	Blower Operating Point	0-999C	005 C	Engineer

3	Temperature C	Zone 3	Set temperature	0-500 C	200 C	Engineer
	Prop. Band C	Zone 3	Proportional band	0-100 C	030 C	Engineer

**INJkon 08/ Manual**



	Integr. Time Sec	Zone 3	Integral time	0-999 Sec	900 Sec	Engineer
	Derivt. Time Sec	Zone 3	Derivative time	0-999 Sec	000 Sec	Engineer
	Cycle Time Sec	Zone 3	Cycle time	0-200 Sec	15 Sec	Engineer
	Alarm Low C	Zone 3	Alarm low	0-200 C	025 C	Engineer
	Alarm High C	Zone 3	Alarm High	0-999 C	025 C	Engineer
	Blower Point C	Zone 3	Blower Operating Point	0-999C	005C	Engineer

4	Temperature C	Zone 4	Set temperature	0-500 C	200 C	Engineer
	Prop. Band C	Zone 4	Proportional band	0-100 C	030 C	Engineer
	Integr. Time Sec	Zone 4	Integral time	0-999 Sec	900 Sec	Engineer
	Derivt. Time Sec	Zone 4	Derivative time	0-999 Sec	000 Sec	Engineer
	Cycle Time Sec	Zone 4	Cycle time	0-200 Sec	15 Sec	Engineer
	Alarm Low C	Zone 4	Alarm low	0-200 C	025 C	Engineer
	Alarm High C	Zone 4	Alarm High	0-999 C	025 C	Engineer
	Blower Point C	Zone 4	Blower Operating Point	0-999C	005 C	Engineer

5	Temperature C	Zone 5	Set temperature	0-500 C	200 C	Engineer
	Prop. Band C	Zone 5	Proportional band	0-100 C	030 C	Engineer
	Integr. Time Sec	Zone 5	Integral time	0-999 Sec	900 Sec	Engineer
	Derivt. Time Sec	Zone 5	Derivative time	0-999 Sec	000 Sec	Engineer
	Cycle Time Sec	Zone 5	Cycle time	0-200 Sec	15 Sec	Engineer
	Alarm Low C	Zone 5	Alarm low	0-200 C	025 C	Engineer
	Alarm High C	Zone 5	Alarm High	0-999 C	025 C	Engineer
	Blower Point C	Zone 5	Blower Operating Point	0-999C	005 C	Engineer

6	Temperature C	Zone 6	Set temperature	0-500 C	200 C	Engineer
	Prop. Band C	Zone 6	Proportional band	0-100 C	030 C	Engineer
	Integr. Time Sec	Zone 6	Integral time	0-999 Sec	900 Sec	Engineer
	Derivt. Time Sec	Zone 6	Derivative time	0-999 Sec	000 Sec	Engineer
	Cycle Time Sec	Zone 6	Cycle time	0-200 Sec	15 Sec	Engineer
	Alarm Low C	Zone 6	Alarm low	0-200 C	025 C	Engineer
	Alarm High C	Zone 6	Alarm High	0-999 C	025 C	Engineer
	Blower Point C	Zone 6	Blower Operating Point	0-999C	005C	Engineer

7	Temperature C	Zone 7	Set temperature	0-500 C	200 C	Engineer
	Prop. Band C	Zone 7	Proportional band	0-100 C	030 C	Engineer
	Integr. Time Sec	Zone 7	Integral time	0-999 Sec	900 Sec	Engineer
	Derivt. Time Sec	Zone 7	Derivative time	0-999 Sec	000 Sec	Engineer
	Cycle Time Sec	Zone 7	Cycle time	0-200 Sec	15 Sec	Engineer
	Alarm Low C	Zone 7	Alarm low	0-200 C	025 C	Engineer
	Alarm High C	Zone 7	Alarm High	0-999 C	025 C	Engineer
	Blower Point C	Zone 7	Blower Operating Point	0-999C	005 C	Engineer

8	Temperature C	Zone 8	Set temperature	0-500 C	200 C	Engineer
	Prop. Band C	Zone 8	Proportional band	0-100 C	030 C	Engineer
	Integr. Time Sec	Zone 8	Integral time	0-999 Sec	900 Sec	Engineer
	Derivt. Time Sec	Zone 8	Derivative time	0-999 Sec	000 Sec	Engineer
	Cycle Time Sec	Zone 8	Cycle time	0-200 Sec	15 Sec	Engineer
	Alarm Low C	Zone 8	Alarm low	0-200 C	025 C	Engineer
	Alarm High C	Zone 8	Alarm High	0-999 C	025 C	Engineer
	Blower Point C	Zone 8	Blower Operating Point	0-999C	005 C	Engineer



Set Miscellaneous

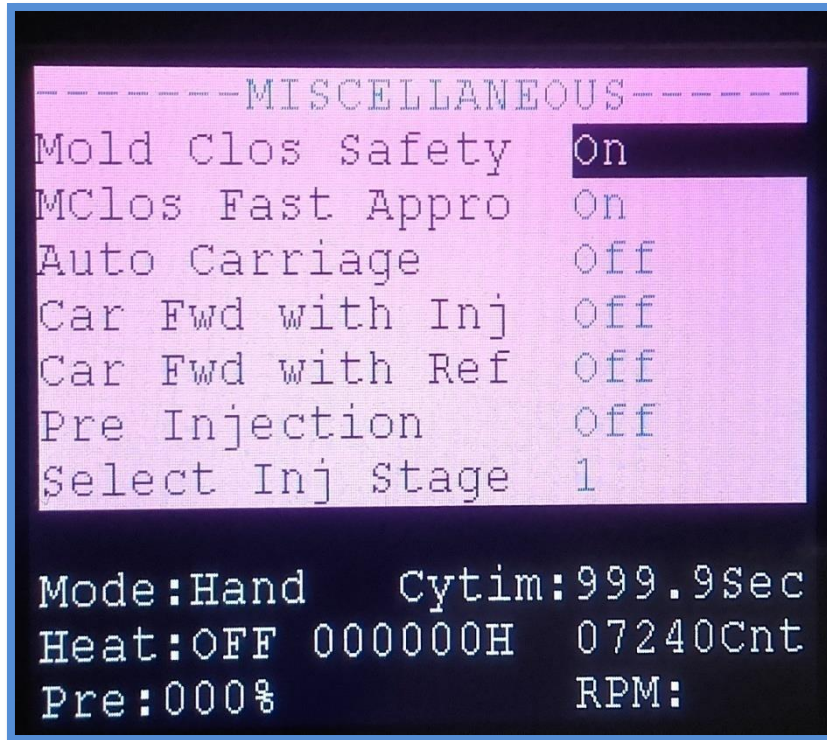

Set Miscellaneous

Press set **MISC** key.

Third line of LCD show function's name and its value/status.

Select require function using **Scroll UP/DOWN** key.

Select Down/UP side parameter Using **Page UP/DOWN** key.

Set require value/ status using **INC, DEC** and **SHIFT** key.

On pressing **NEXT** key the set value will be saved and display will show the function.

List of miscellaneous parameters are given below.

No.	Message	Description	Range	Default Value	Level
1	Mold Safty	Mold Safety Operation On/Off	On / Off	Off	Supervisor
2	MClS Bost	Mold Close Boost Option	0000-0003	0000	Supervisor
3	Lock Ton2	Locking Tonnage 2 On/Off	On / Off	Off	User
4	Auto Carrg	Auto Carriage On/Off	On / Off	Off	Supervisor
5	Carr W Inj	Carriage With Injection Function	On / Off	On	Supervisor
6	Flow Inj	Flow Injection Option On/Off	On / Off	Off	Supervisor
7	Inj. Boost	Injection Boost Option	0000-0002	0000	Supervisor
8	Refil Boost	Refill Boost On/Off	0000-0002	0000	Supervisor
9	RPM Intlk	RPM Interlock On/Off	On / Off	Off	Supervisor
10	LoRPM Scrw	Minimum RPM limit to operate screw	0-20	0000	Supervisor
11	PPR Screw	Screw pulse per revolution	0-4	0001	Supervisor
12	Suckback	Suck Back On/Off	On / Off	On	Supervisor
13	Decomp On	Decompression On/Off	On / Off	Off	Supervisor
14	Ejct Prog	Ejector Operating Program	0-2	0002	Supervisor
15	Ejct Shot	Ejector Shot	0-5	0001	User
16	EjBak l/L	Ejector backward interlock On/Off	On / Off	Off	Supervisor
17	Core 1 On	Core 1 On/Off	On / Off	Off	Supervisor
18	Core 2 On	Core 2 On/Off	On / Off	Off	Supervisor



19	Cor In Pos	Core In Position	0000-0002	0000	Supervisor
20	CorOut Pos	Core Out Position	0000-0002	0000	Supervisor
21	Core 1 I/L	Core 1 interlock On/Off	On / Off	Off	Supervisor
22	Core 2 I/L	Core 2 interlock On/Off	On / Off	Off	Supervisor
23	Clamp Advnc	Clamp advance On/Off	On / Off	Off	Supervisor
24	Slide	Slide On/Off	On / Off	Off	Supervisor
25	% Heat Zn1	Set Temperature of % Heating Zone 1	0-100%	0000	User
26	% Zn1 CyTm	Cycle time of % Heating Zone 1	0-100Sec	0000	User
27	% Heat Zn2	Set Temperature of % Heating Zone 2	0-100%	0000	User
28	% Zn2 CyTm	Cycle time of % Heating Zone 2	0-100Sec	0000	User
29	Purge Mode	Purge Mode On/Off	On / Off	Off	Supervisor
30	TestIn/Out	Test Mode On/Off	On / Off	Off	Supervisor
31	Test Temp	Test Temperature Mode On/Off	On / Off	Off	Supervisor
32	Count Rst	Reset the Shot Counter	On / Off	Off	User
33	Maxm Pres	Maximum Pressure Setting	0-100bar	100 bar	Supervisor
34	Mold Memry	Mold Memory Selection	0-50	0000	Supervisor
35	Cor In Inj	Core in with injection time	On/Off	Off	Supervisor
36	Cor In1 I/L	Core 1 In Interlock On/Off	On/Off	Off	Supervisor
37	Cor In2 I/L	Core 2 In Interlock On/Off	On/Off	Off	Supervisor
38	EjBk @Mcls	Ejector Backward with Mold Close	On/Off	Off	Supervisor
39	Fast Appro	Fast Approach	On/Off	On	Supervisor
40	Ej.Plate	Ejector Plate back interlock On/Off	On/Off	Off	Supervisor
41	MopnIL WEj	Mold Open Interlock for Ejector Function	On/Off	On	Supervisor
42	Ejct Boost	Ejector Boost Option	0000-0003	0000	Supervisor
43	Cor1 Boost	Core 1 Boost Option	0000-0003	0000	Supervisor
44	Cor2 Boost	Core 2 Boost Option	0000-0003	0000	Supervisor
45	MOpn Boost	Mold Open Boost Option	0000-0002	0000	Supervisor
46	Zon 8: Oil	Temperature zone 8 select as oil temperature	On/Off	On	Supervisor
47	Oil Temp.	Set oil temperature	0000-0060	0060	Supervisor
48	Adaptive Control	If tern ON manual PID will be disable & automatic PID will be ON	On/Off	Off	Supervisor
49	Set Batch Cntr	Batch Counter preset value. The batch counter resets on reaching this Count. On overflow batch counter system comes into HAND mode. On setting value 00000 disables the counter.	00000-9999	000000	supervisor
50	Batch Cnt Reset	Batch counter reset enable (on) or disable (off). When put to on, reset the 5-digit batch counter reset to 0.	On/Off	Off	User Level
51	Totalizer reset	If set to on, totalize counter is reset to zero.	On/Off	Off	User Level
52	Hour Cnt reset	If set to on, hour counter is reset to zero.	On/Off	Off	User Level
53	Piece fall	For piece fall confirmation needed during cycle	On/Off	OFF	Supervisor
54	Mold Side	Analog input (Linear Transducer or Encoder) select POSI (position) mode operating type. In case use of Digital Input (Limit Switches or Proximity Switches) select LS mode operating type	Posiion/LS	Postion	Supervisor
55	Injection	Select injection-operating type. In case use of Analog input (Linear Transducer	Position/LS/Ti mer	Timer	Supervisor

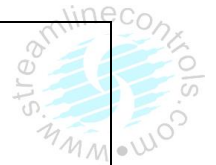

		or Encoder) select POSI (position) mode operating type. In case use of Digital Input (Limit Switches or Proximity Switches) select LS mode operating type. None of above two operating type feedback select TIMR mode operating type.			
56	Refill	Select refill-operating type. In case use of Analog input (Linear Transducer or Encoder) select POSI (position) mode operating type. In case use of Digital Input (Limit Switches or Proximity Switches) select LS mode operating type.	Position/LS	Position	Supervisor
57	Suckback	Select suck back-operating type. In case use of Analog input (Linear Transducer or Encoder) select POSI (position) mode operating type. In case use of Digital Input (Limit Switches or Proximity Switches) select LS mode operating type. None of above two operating type feedback select TIMR mode operating type.	Position/LS/Timer	Timer	Supervisor
58	Ejector	Select ejector-operating type. In case use of Analog input (Linear Transducer or Encoder) select POSI (position) mode operating type. In case use of Digital Input (Limit Switches or Proximity Switches) select LS mode operating type	Position/LS/Timer	Timer	Supervisor
59	Tonnage 1	Select tonnage1-operating type. In case use of Analog input (Pressure Transducer) select POSI (position) mode operating type. In case use of Digital Input (Limit Switches or Proximity Switches) select LS mode operating type. None of above two operating type feedback select TIMR mode operating type.	Position/LS/Timer	Timer	Supervisor
60	Tonnage 2	Select tonnage2-operating type. In case use of Analog input (Pressure Transducer) select POSI (position) mode operating type. In case use of Digital Input (Limit Switches or Proximity Switches) select LS mode operating type. None of above two operating type feedback select TIMR mode operating type.	Position/LS/Timer	Timer	Supervisor
61	Decompression	Select decompression-operating type. In case use of Analog input (Pressure Transducer) select POSI (position) mode operating type. In case use of Digital Input (Limit Switches or Proximity Switches) select LS mode operating type. None of above two operating type feedback select TIMR mode operating type. If decompression function is not available in machine then made it OFF.	Position/LS/Timer	Timer	Supervisor
62	Carriage	Select carriage-operating type. In case use of Digital Input (Limit Switches or Proximity Switches) select LS mode operating type. Otherwise select TIMR mode operating type. In case use of Analog input (Linear Transducer) select POSI (position) mode operating type.	Position/LS/Timer	OFF	Supervisor
63	Pres Low Limit	pressure low Limit Value	0-4000	0000	supervisor
64	Pres High Limit	Pressure High Limit Value (Calibration)	0-4000	2000	supervisor
65	Flow Low Limit	Flow Low Limit Value	0-4000	000	Supervisor

66	Flow High Limit	Flow High Limit Value (Calibration)	0-4000	4000	Supervisor
67	Select Calibrate	Select various type of calibration mode. I.e. Temperature, Analog Input, Analog Output	Analog AIPS/Temp/Analog AOPS	OFF	Supervisor
68	Password Level 1	Set password level 1 to protect software decided configures parameters at level 1.	0000-9999	0000	Supervisor
69	Password Level 2	Set password level 2 to protect software decided configures parameters at level 2.	0000-9999	1111	Supervisor
70	Password Level 3	Set password level 3 to protect software decided configures parameters at all level.	0000-9999	2222	Supervisor
71	Paswad Lok Delay	Set password lock delay. If there is no any data entry within this set time open any password level is lock automatically.	00-99	000	supervisor
72	Load Factory Set	Default All Parameter	On/Off	Off	Supervisor
73	RTC: Hour	Set current time in hour HH: Shows hour	00-23		Supervisor
74	RTC: Minute	Set Current Minutes.	00-59		Supervisor
75	RTC:Date	Set Current Date			Supervisor
76	RTC: Month	Set Current Month			Supervisor
77	RTC: Year	Set Current Year			Supervisor

**STANDARD EJECTOR PROGRAM :**

1. Program 00: Ejector disable.
2. Program 01: Ejector Forward only after mold gets fully open.
3. Program 02: Ejector Forward/Hold/Backward

i.e. Full Shot after mold gets fully open.  
No. of shots is programmable.

**Core Position Set Misc:**

**Core IN Position:**

1. Set 00: Before Mold Close
2. Set 01: In between Mold Close
3. Set 02:After Mold Close

**Core OUT Position:**

1. Set 00: Before Mold Open
2. Set 01: In between Mold Open
3. Set 02:After Mold Open



**Set Timer**



**Set Timer**

Press set **TIMER** key.

Third line of LCD show function's name and it's set value.

Select require function using **Scroll UP/DOWN** key.

Select Down/UP side parameter Using **Page UP/DOWN** key.

Set require time using **INC, DEC** and **SHIFT** key.

On pressing **NEXT** key the set value will be saved and display will show the function.

List of timer parameters are given below.

No.	Message	Description	Range	Default Value	Level
1	Mold Close	Mold slow close time	0-999.9 Sec	001.0	User
2	Mold Safty	Mold safety time	0-999.9 Sec	002.0	User
3	Carr.Forwd	Carriage Forward time	0-999.9 Sec	003.0	User
4	Pre-Inject	Pre Injection time	0-999.9 Sec	001.0	User
5	Flow Inj	Flow Injection time	0-999.9 Sec	001.0	User
6	Injct Dely	Injection delay	0-999.9 Sec	001.0	User
7	Inject 1	Injection 1 time	0-999.9 Sec	001.0	User
8	Inject 2	Injection 2 time	0-999.9 Sec	001.0	User
9	Inject 3	Injection 3 time	0-999.9 Sec	001.0	User
10	Inject 4	Injection 4 time	0-999.9 Sec	001.0	User
11	Inject Hld	Injection Hold time	0-999.9 Sec	001.0	User
12	Sukbk1 Dly	Suck back 1 Delay	0-999.9 Sec	001.0	User
13	Sukbk1 Tim	Suck back 1 Time	0-999.9 Sec	001.0	User
14	CarrBk Dly	Carriage backward delay	0-999.9 Sec	003.0	User
15	Intens Dly	Intensifier delay	0-999.9 Sec	001.0	User
16	Intens Tim	Intensifier time	0-999.9 Sec	001.0	User
17	Air Cavity	Air Cavity time	0-999.9 Sec	001.0	User



18	Refil Dely	Refill delay	0-999.9 Sec	001.0	User
19	Refil Time	Refill time	0-999.9 Sec	001.0	User
20	Sukbk2 Dly	Suck back 2 Delay	0-999.9 Sec	001.0	User
21	Sukbk Time	Suck back time	0-999.9 Sec	001.0	User
22	Cool Time	Cool time	0-999.9 Sec	005.0	User
23	Carr.Bakwd	Carriage backward time	0-999.9 Sec	001.0	User
24	Mold Open	Mold open slow time	0-999.9 Sec	001.0	User
25	Ejct Dely	Ejector delay	0-999.9 Sec	000.5	User
26	Ejct Forwd	Ejector Forward time	0-999.9 Sec	002.0	User
27	Ejct Hold	Ejector Hold time	0-999.9 Sec	000.5	user
28	Ejct Bakwd	Ejector Backward time	0-999.9 Sec	002.0	User
29	Air Punch	Air Punch time	0-999.9 Sec	001.0	User
30	Cycle Dely	Cycle delay	0-999.9 Sec	005.0	User
31	Cycle Time	Cycle time	0-999.9 Sec	999.9	Supervisor
32	Core 1 In	Core 1 In time	0-999.9 Sec	001.0	User
33	Core 1 Out	Core 1 Out time	0-999.9 Sec	001.0	User
34	Core 2 In	Core 2 In time	0-999.9 Sec	001.0	User
35	Core 2 Out	Core 2 Out time	0-999.9 Sec	001.0	User
36	To Heat On	To Heat On delay	0-999.9 Sec	010.0	Supervisor
37	Prop On Dly	Delay between direction valve & prop. On time	0-999.9 Sec	000.1	Supervisor
38	Unscr Dely	Unscrew Delay Time	0-999.9 Sec	001.0	User
39	Unscr Time	Unscrew Time	0-999.9 Sec	001.0	User
40	Tot Inj Tim	Total Injection time	0-999.9 Sec	001.0	User
41	Cor1 P Dly	Core 1 partial out delay	0-999.9 Sec	001.0	User
42	Cor1 P Tim	Core 1 partial out time	0-999.9 Sec	001.0	User
43	Cor2 P Dly	Core 2 partial out delay	0-999.9 Sec	001.0	User
44	Cor2 P Tim	Core 2 partial out time	0-999.9 Sec	001.0	User
45	AirCav Dly	Air Cavity 1 delay	0-999.9 Sec	001.0	User
46	AirCav2 DI	Air Cavity 2 delay	0-999.9 Sec	001.0	User
47	AirCav2 Tm	Air Cavity 2 time	0-999.9 Sec	001.0	User
48	InjBost DI	Injection Boost delay time	0-999.9 Sec	001.0	User
49	InjBost Tm	Injection Boost On time	0-999.9 Sec	001.0	User



**Set Pressure**

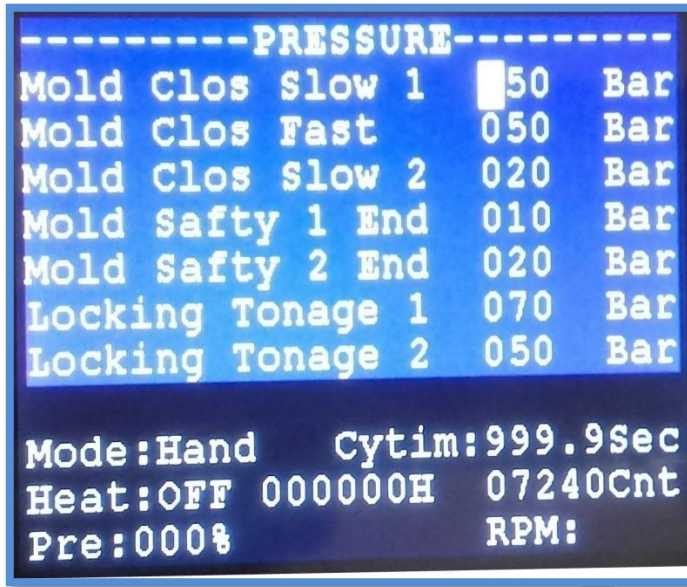

**Set Pressure**

Press set **Pressure** key.

Third line of LCD show function's name and it's set value.

Select require function using **Scroll UP/DOWN** key.

Select Down/UP side parameter Using **Page UP/DOWN** key.

Set require time using **INC, DEC** and **SHIFT** key.

On pressing **NEXT** key the set value will be saved and display will show the function.

List of timer parameters are given below.

No.	Message	Description	Range	Default Value	Level
1	Mold Close	Set Mold Close function operating pressure proportional output	0-100 bar	030	User
2	Mold Safety	Set Mold Safety function operating pressure proportional output	0-100 bar	030	User
3	Locking Tonnage	Set Locking Tonnage function operating pressure proportional output	0-100 bar	030	User
3	Carr.Forwd	Set Carr. Forward function operating pressure proportional output	0-100 bar	030	User
4	Pre-Inject	Set Pre-Injection function operating pressure proportional output	0-100 bar	030	User
5	Intrusion	Set Intrusion function operating pressure proportional output	0-100 bar	030	User
6	Inject 1	Set Injection 1 function operating pressure proportional output	0-100 bar	030	User
8	Inject 2	Set Injection 2 function operating pressure proportional output	0-100 bar	030	User
9	Inject 3	Set Injection 3 function operating pressure proportional output	0-100 bar	030	User
10	Inject 4	Set Injection 4 function operating pressure proportional output	0-100 bar	030	User

**INJkon 08/ Manual**



11	Inject Hld	Set Injection Hold function operating pressure proportional output	0-100 bar	030	User
12	Suckback1	Set Suckback 1 function operating pressure proportional output	0-100 bar	030	User
13	Suckback 2	Set Suckback 2 function operating pressure proportional output	0-100 bar	030	User
14	Refill 1	Set Refill 1 function operating pressure proportional output	0-100 bar	030	User
15	Refill 2	Set Refill 2 function operating pressure proportional output	0-100 bar	030	User
16	Refill Dely	Set Refill Delay function operating pressure proportional output	0-100 bar	030	User
17	Intensifier	Set Intensifier function operating pressure proportional output	0-100 bar	030	User
18	Cooling	Set Cooling function operating pressure proportional output	0-100 bar	030	User
19	Decompression	Set Decompression function operating pressure proportional output	0-100 bar	030	User
20	Mold Open	Set Mold Open function operating pressure proportional output	0-100 bar	030	User
21	Mold Height	Set Mold Height function operating pressure proportional output	0-100 bar	030	User
22	Ejct Forward1	Set Ejct..Forward 1 function operating pressure proportional output	0-100 bar	030	User
23	Ejct Forward2	Set Ejct.Forward 2 function operating pressure proportional output	0-100 bar	030	User
24	Ejct Backward	Set Ejct.Backward function operating pressure proportional output	0-100 bar	030	User
25	Core	Set Core function operating pressure proportional output	0-100 bar	030	User
26	Unscrew	Set Unscrew function operating pressure proportional output	0-100 bar	030	User

STREAMLINE CONTROLS



**Set Flow**



<b>Set Flow</b>					
Press set <b>Flow</b> key.					
Third line of LCD show function's name and it's set value.					
Select require function using <b>Scroll UP/DOWN</b> key.					
Select Down/UP side parameter Using <b>Page UP/DOWN</b> key.					
Set require time using <b>INC, DEC</b> and <b>SHIFT</b> key.					
On pressing <b>NEXT</b> key the set value will be saved and display will show the function.					
List of timer parameters are given below.					
No.	Message	Description	Range	Default Value	Level
1	Mold Close	Set Mold Close function operating Flow proportional output	0-100 bar	030	User
2	Mold Safty	Set Mold Safety function operating Flow proportional output	0-100 bar	030	User
3	Locking Tonnage	Set Locking Tonnage function operating Flow proportional output	0-100 bar	030	User
3	Carr.Forwd	Set Carr.Forward function operating Flow proportional output	0-100 bar	030	User
4	Pre-Inject	Set Pre-Injection function operating Flow proportional output	0-100 bar	030	User
5	Intrusion	Set Intrusion function operating Flow proportional output	0-100 bar	030	User
6	Inject 1	Set Injection 1 function operating Flow proportional output	0-100 bar	030	User
8	Inject 2	Set Injection 2 function operating Flow proportional output	0-100 bar	030	User



INJkon 08/ Manual



9	Inject 3	Set Injection 3 function operating Flow proportional output	0-100 bar	030	User
10	Inject 4	Set Injection 4 function operating Flow proportional output	0-100 bar	030	User
11	Inject Hld	Set Injection Hold function operating Flow proportional output	0-100 bar	030	User
12	Suckback1	Set Suckback 1 function operating Flow proportional output	0-100 bar	030	User
13	Suckback 2	Set Suckback 2 function operating Flow proportional output	0-100 bar	030	User
14	Refill 1	Set Refill 1 function operating Flow proportional output	0-100 bar	030	User
15	Refill 2	Set Refill 2 function operating Flow proportional output	0-100 bar	030	User
16	Refil Dely	Set Refill Delay function operating Flow proportional output	0-100 bar	030	User
17	Intensifier	Set Intensifier function operating Flow proportional output	0-100 bar	030	User
18	Cooling	Set Cooling function operating Flow proportional output	0-100 bar	030	User
19	Decompression	Set Decompression function operating Flow proportional output	0-100 bar	030	User
20	Mold Open	Set Mold Open function operating Flow proportional output	0-100 bar	030	User
21	Mold Height	Set Mold Height function operating Flow proportional output	0-100 bar	030	User
22	Ejct Forward1	Set Ejct..Forward 1 function operating Flow proportional output	0-100 bar	030	User
23	Ejct Forward2	Set Ejct.Forward 2 function operating Flow proportional output	0-100 bar	030	User
24	Ejct Backward	Set Ejct.Backward function operating Flow proportional output	0-100 bar	030	User
25	Core	Set Core function operating Flow proportional output	0-100 bar	030	User
26	Unscrew	Set Unscrew function operating Flow proportional output	0-100 bar	030	User



**Set Postion**



No.	Message	Description	Range	Level
1	Mold Close Slow 1	Set End Position for Close Slow 1 operation	Low than mold open slow 3	User
2	Mold Close Fast	Set Mold close Fast function over operating position.	Low than Mold Close slow1	User
3	Mold Close Slow 2	Set Close Slow 2 function over operating position.	Low than mold close fast	User
3	Mold CLS Safety1	Set Mold close Safety 1 function over operating position.	Low than Mold Close slow 2	User
4	Mold Cls Safety2	Set Close Safety 2 function over operating position.	Low than Mold cls safety 1	User
5	Preinjection	Set Pre Injection function over operating position	Low than refill 2 position value	User
6	Inject 1	Set Injection Stage-1 function over operating position	Low than Refill2 position value	User
8	Inject 2	Set Injection Stage-2 function over operating position	Low than Inj 1 position value	User
9	Inject 3	Set Injection stage' 3 function over operating position	Low than Inj 2 position values	User
10	Inject 4	Set Injection 4 function over operating position	Low than Inj3 position value	User
11	Refill 1	Set Refill-1 function over operating position.	High than inj 1 position value	User
12	Refill 2	Set Refill-2 function over operating position.	High than Refill 1 position value	User
13	Suck back 2	Set Suckback 2 function operating position	High Than Refll 2 position value	User
14	Mold Open Slow 1	Set Mold open Slow 1 function operating position	High Than mold close slow1	User
15	Mold Open Fast	Set Mold Open fast function operating position	High Than Mold open slow1 position value	User
16	Mold Open Slow 2	Set Mold open slow 2 function operating position	High Than mold open fast position value	User
17	Mold Open Slow 3	Set Mold open slow 3 function operating position	High Than mold open Slow 2 position value	User



# WIRING DIAGRAM

**Wiring Diagram:** Below is an example of how to do wiring.  
 (View Digital output name, digital input name, analog input name, analog output name and thermocouple input name according to programming sequence code.)

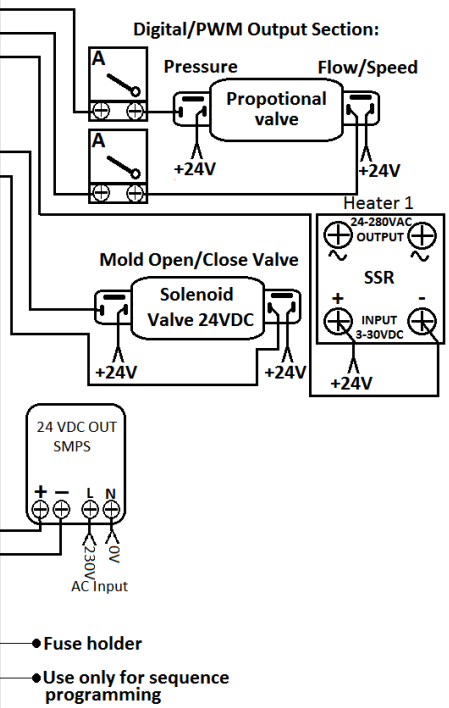
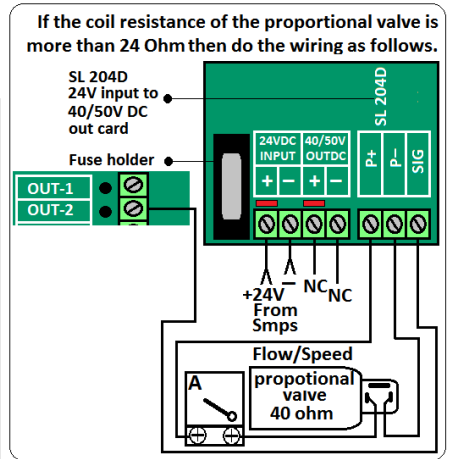
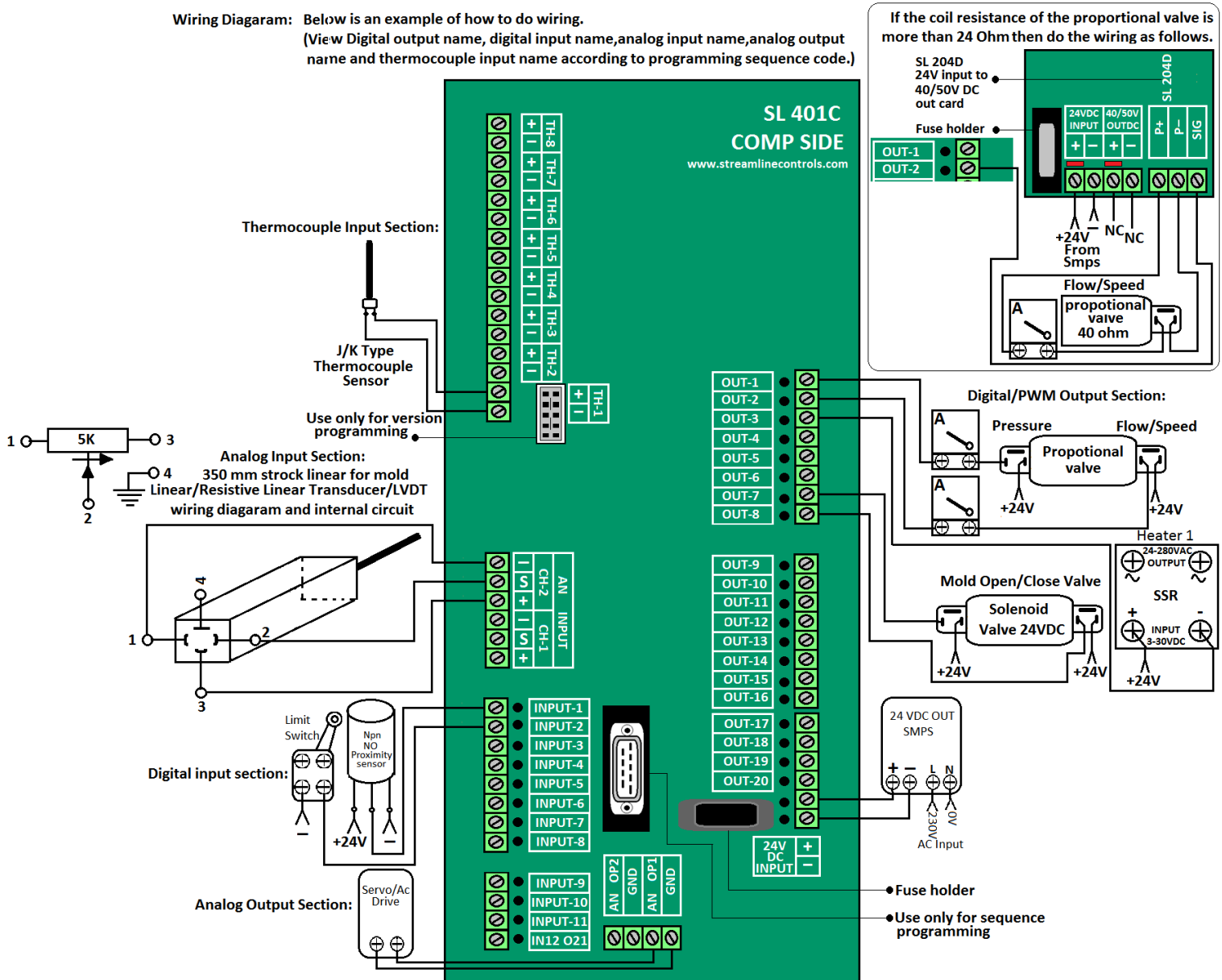

STRE



(J) Home, About us & Password Page

1. Home Page

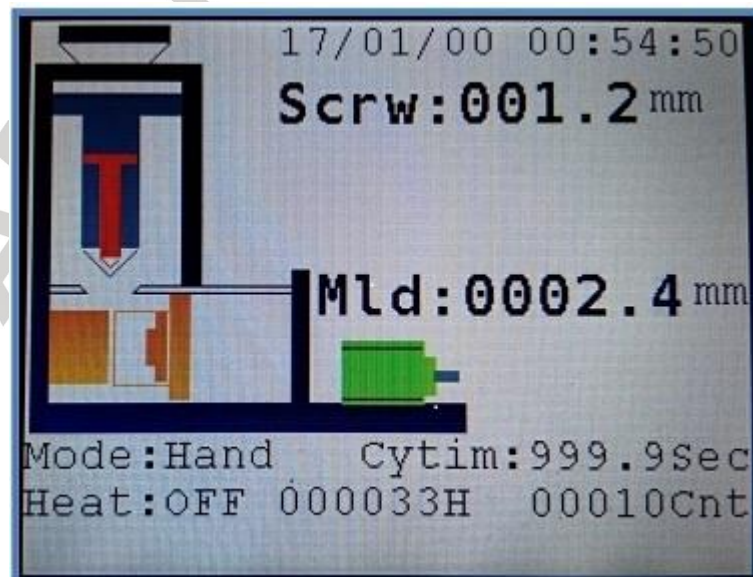
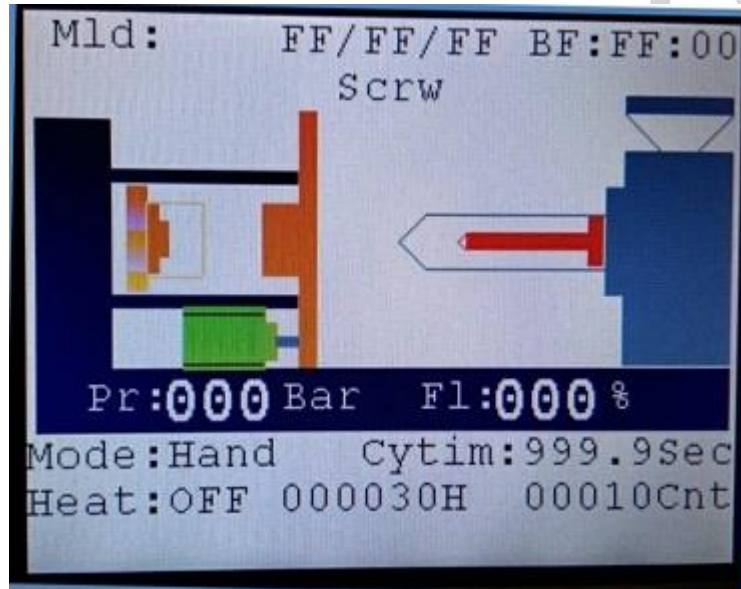



## 2. About us Page.

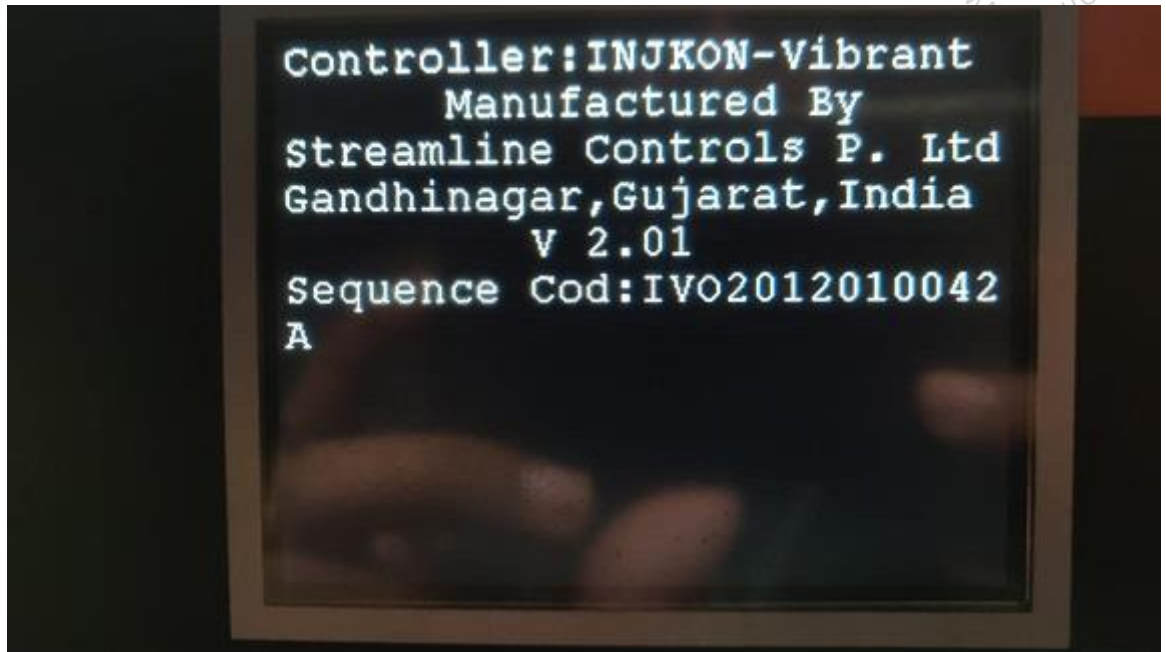

## 3. Password Page.

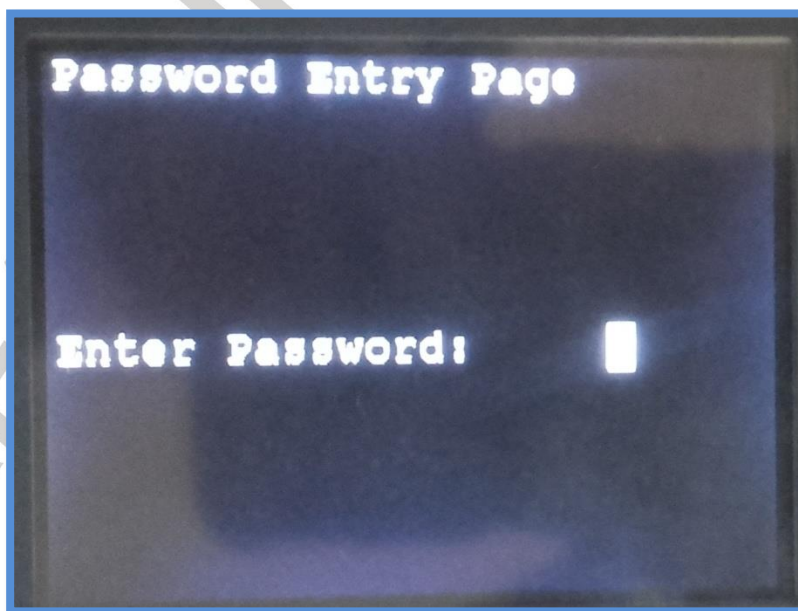

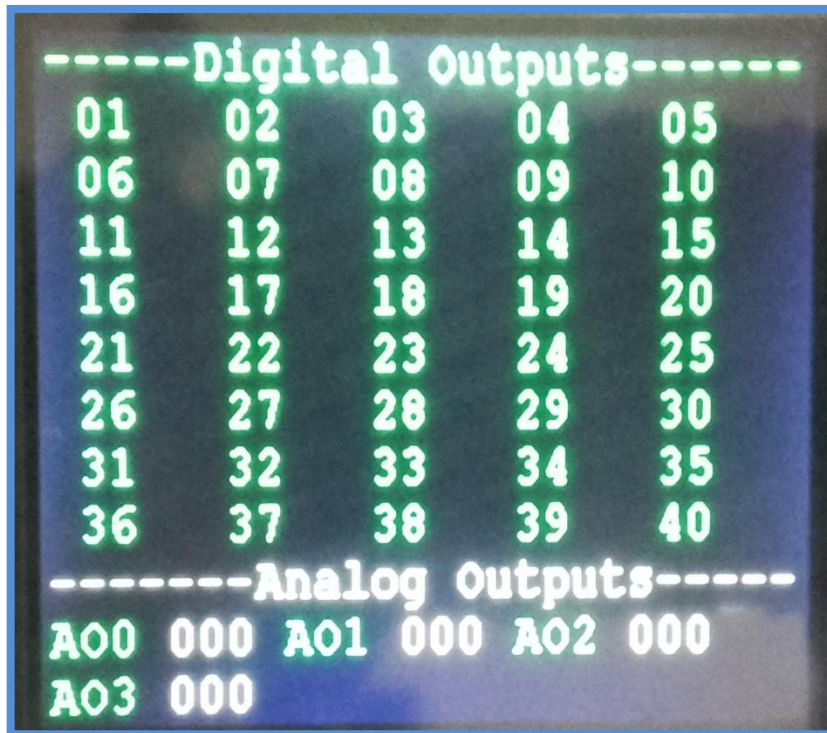
**(K) DESCRIPTION OF TEST MODES****1. OUTPUT TEST MODE:**

- This mode is useful for testing each output of the system.
- This mode is enabled when **Test In/Out** is ON .(Push the **Test** Key and then on the test in/out mode.)  
first line of LCD shows output being checked. When any output is activated, its particular count is shown on LCD. Please refer list of inputs & outputs for more information. Every output is provided with particular count.
- The output can be made **ON** or **OFF** using **NEXT** key.
- The O/P under test can be changed using **INC/DEC** key.
- If the O/P goes **ON** and **OFF** as per the status show on the display, we can say that the wiring & electronic path of the system for that O/P is correct.
- During this mode all other functions are disabled.
- To disable the test mode made off the **test In/Out** in **Press Test key** .



**(3) TEMPERATURE TEST MODE**

- This mode is useful for testing individual temp loop
- This mode can be enabled by making **Test Temp.** in **set misc. menu ON.**
- During this mode only one channel is displayed.
- The zone under testing can be changed using **INC or DEC** key.
- To disable the test TEMP. mode made off the **Test TEMP.** in **set misc menu.**
- During this test mode all other functions are disabled.

**Calibration Method For Temperature**

Procedure	
Step 1	Press " Password " Key and Enter Level "3" Password
Step 2	Go to SET MISC Page by pressing " SET MISC " Key then press Page DN key.
Step 3	Go to " Temp. Calibration Option " and Press INC/DEC Key to ON Temp. Calibration Mode ON then Press Next Key to Save .
Step 4	Exit from the SET MISC by pressing " SET MISC " Key
Step 5	Insert mili volt generator in zone 1 or link in zone 1(+ and -)of " Temperature card " and set 0 mV in it and verify the actual room temp. in " CH 0 ACT Temp " if not achieved Set " Offset "INC/DEC Key and press "NEXT" to Save.
Step 6	Set 10 mV thru mili volt generator Verify " CH 0 ACT Temp "
Step 7	If not achieved the said value ( it should be $185 * m.v + \text{Room Temperature value}$ ) in " CH 0 ACT Temp " , set it in " Gain " Value [To toggle Gain / Offset by Set Temp key and Set Value by INC/DEC Keys ]
Step 8	Once Gain Value set by INC/DEC key press NEXT for saving the " Gain " Value
Step 09	Go to SET MISC by direct pressing " SET MISC " key
Step 10	Do Calibration " OFF " by Pressing " INC/DEC Key " in " CALIBRATE " and Exit from the Page.

**Calibration Method For Analog Inputs**

Procedure	
Step 1	Press " Password " Key and Enter Level "3" Password
Step 2	Go to SET MISC Page by pressing " SET MISC " Key then press Page DN key.
Step 3	Go to " Calibration Option " and Press INC/DEC Key to ON ANLG AIPS Calibration Mode ON then Press Next Key to Save .
Step 4	Exit from the SET MISC by pressing " SET MISC " Key
Step 5	For Cursor in this Page. Select Low Limit And High Limit of respective Channel
Step 6	Take mold at mold fully close position with help of mold close function. Now Enter actual count displayed under <b>CNT</b> column in <b>LCNT</b> and save mold minimum limit. Take mold at mold fully Open position with help of mold open function. Now Enter actual count displayed under <b>CNT</b> column in <b>HCNT</b> and save mold minimum limit.
Step 7	Thus it is end of mold side calibration. For Screw Calibration ,
Step 8	Repeat Step 6 above procedure for other scale also.
Step 09	Go to SET MISC by direct pressing " SET MISC " key
Step 10	Do Calibration " OFF " by Pressing " INC/DEC Key " in " CALIBRATE " and Exit from the Page.



### Calibration Method For Analog Output

Procedure- AC DRIVE/SERVO DRIVE	
Step 1	Press " Password " Key and Enter Level "3" Password
Step 2	Go to SET MISC Page by pressing " SET MISC " Key then press Page DN key.
Step 3	Go to " Calibration Option " and Press INC/DEC Key to ON ANLG AOPS Calibration Mode ON then Press Next Key to Save .
Step 4	Exit from the SET MISC by pressing " SET MISC " Key
Step 5	In Calibration AOPS page for default press HAND key.
Step 6	
Step 7	
Step 8	For Proportional calibration- No need to ON calibration AOPS.
Step 09	For Pressure calibration, in Set misc Pressure Low limit and Pressure High Limt parameter Set count as per required in Gauge for 0 Pressure and 100 pressure and do power OFF/ON to save parameter.
Step 10	For Flow calibration, in Set misc Flow Low limit and Flow High Limit parameter Set count as per required in Amp meter for 0 Flow and 100 Flow and do power OFF/ON to save parameter.



**(L) FUNCTIONAL DESCRIPTIONS****(1) HEAT ON / OFF:**

Heating off function can be enabled or disabled using **HEAT OFF**, key. When heating off is active **HOFF** indicate in second line of display. And all output of heater goes OFF. When heating is **ON PV** indicate in second line of display. And all heater outputs operate as per control action of temp. Controller.

**(2) HAND:**

System (after power on) starts in HAND MODE. In this mode all the functions (like mold open, mold close, unit forward etc) can be done using different function keys.

**For ex. :** Mold can be opened using mold open key. When any interlock appears during cycle the machine transferred in to hand mode.

**(3) SEMI AUTO:**

On pressing **SEMI AUTO** key cycle starts.

Cycle stops after completion of one cycle. Here cycle can be restarted by opening and closing of front guard.

**(4) FULLY AUTO:**

On pressing **AUTO** key the auto cycle starts.

Here after completion of one cycle, cycle delay timer starts after completion of **cycle delay** cycle restarts.



**(M) INTERLOCKS**

It is a one type of alarm system which activate when cycle or any other function does not operate properly because of those abnormal condition it indicate INTERLOCK

Following are the different interlock messages.

Sr.No.	Operation	Interlocks Messages On Screen	Description Of Messages	Type Of Mode		
				Hand	Semi Auto	Fully Auto
1	Mold Open	IL Mold Open End	Mold fully open end		y	y
		IL Mold Open/Clos On	Mold open close limits on	y	y	y
2	Mold Close	IL Mold Close End	Mold fully Close end		y	y
		IL Mold Safty Tm Ovr	Mold Safety time over	y	y	y
		IL Mold Open/Clos On	Mold open close limits on	y	y	y
3	Unit Forward	IL Carriage For End	Carriage Forward End	y	y	y
4	Unit Backward	IL Carriage Back End	Carriage Backward End	y	y	y
5	Injection	IL Temperature Low	Temperature is low	y	y	y
		IL Temperature High	Temperature is High	y	y	y
6	Refill	IL Refill End	Refill End	y	y	y
		IL Temperature Low	Temperature is low	y	y	y
		IL Temperature High	Temperature is High	y	y	y
		IL RPM too Low.	Screw RPM is low	y	y	y
7	Suck Back	IL Temperature Low	Temperature is low	y	y	y
		IL Temperature High	Temperature is High	y	y	y
		IL Suckback End	Suck back End	y	y	y
8	Ejector Forward	IL Eje Forward End	Ejector Forward end	y	y	y
9	Ejector Backward	IL Eje Backward End	Ejector Backward end	y	y	y
		IL Ejector Not Back	Ejector not back	y	y	y
10	Core 1 In	IL Core 1 In End	Core 1 in End	y	y	y
11	Core 1 Out	IL Core 1 Out End	Core 1 out End	y	y	y
		IL Core 1 not Out	Core 1 not out	y	y	y
12	Core 2 In	IL Core 2 In End	Core 2 in End	y	y	y
13	Core 2 Out	IL Core 2 Out End	Core 2 out End	y	y	y
		IL Core 2 not Out	Core 2 not out	y	y	y
14	Mold Height Min.	IL Mold Hght Min End	Mold Height minimum End	y	y	y
		IL Mold Height Min.	Mold Height minimum	y	y	y
15	Mold Height Max.	IL Mold Hght Max End	Mold Height maximum End	y	y	y
		IL Mold Height Max.	Mold Height maximum	y	y	y
16	Temperature	IL Temperature Low	Temperature is low	y	y	y
		IL Temperature High	Temperature is High	y	y	y
		IL Oil Temp. High	Oil temperature is high	y	y	y
17	Common	IL Front Guard Open	Front door open	y	y	y
		IL Back Guard Open	Rear door open	y	y	y
		IL Cycle Time Over	Cycle time over	y	y	y
		IL Emergency Press	Emergency press	y	y	y
		IL Motr not on Delta	Hydraulic motor not on Delta	y	y	y

**OUR PRODUCT RANGE**



- Dedicated Controller for Plastic Injection molding Machines
- Dedicated Controller For Blow Molding Machine
- Dedicated Controller For Pet Stretch Molding Machine
- Dedicated Controller For Hopper Loader
- AC Servo Motor Drive
- DC Stepper Drive
- Dedicated Controller For Bag Making Machine
- Dedicated Controller For Sticker Labeling Machine
- Dedicated Controller For Grinding Machine
- Dedicated Controller For Dozing Application
- Dedicated Controller For Pad Printing Machine
- Dedicated Controller For Jet Dyeing Machine
- Application Specific Packages
- All Servo Pick & Place Robot For IMM
- Time/Temperature Based Profile Generator
- Multi Channel Temperature Controller
- 2/3/4 Axes Motion Controllers ( Using DC stepper / AC Servo Drives).